

## L0QX301 IEC Flameproof Enclosure - Ex d

### Only One Flameproof Box

Pre-Wired And Pre-Tested

Reduces installation time and cost

Consistent, predictable machine overhaul schedule

Simplified supply chain

Uniform documentation

Standardised machine automation software

Sub - Systems designed to work together from single supplier

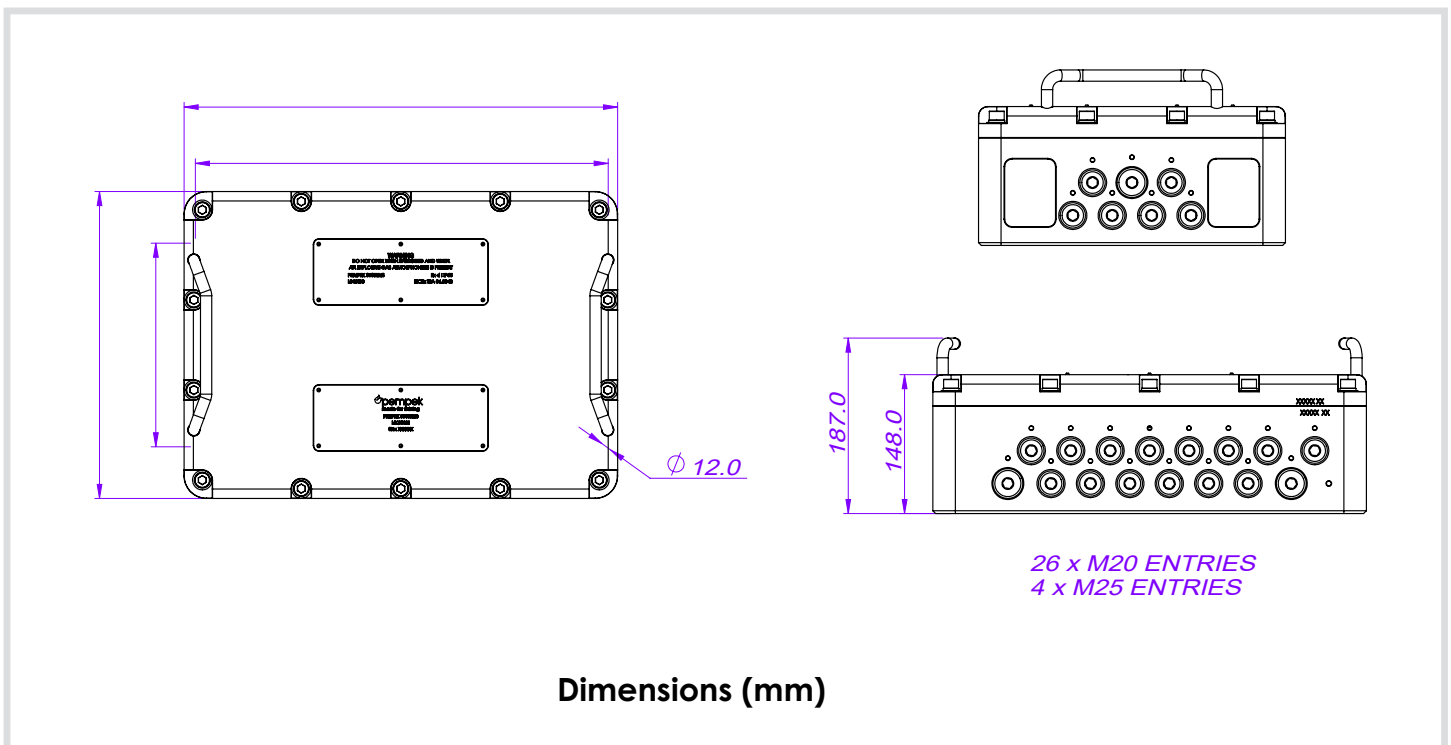

**26 x M20 ENTRIES**  
**4 x M25 ENTRIES**

L0QX301 IEC Flameproof Enclosure - Ex d

Complete Cost-Effective Control Systems For Flameproof Mobile Plant

Example - 12cm12 Place Change Machine Control System

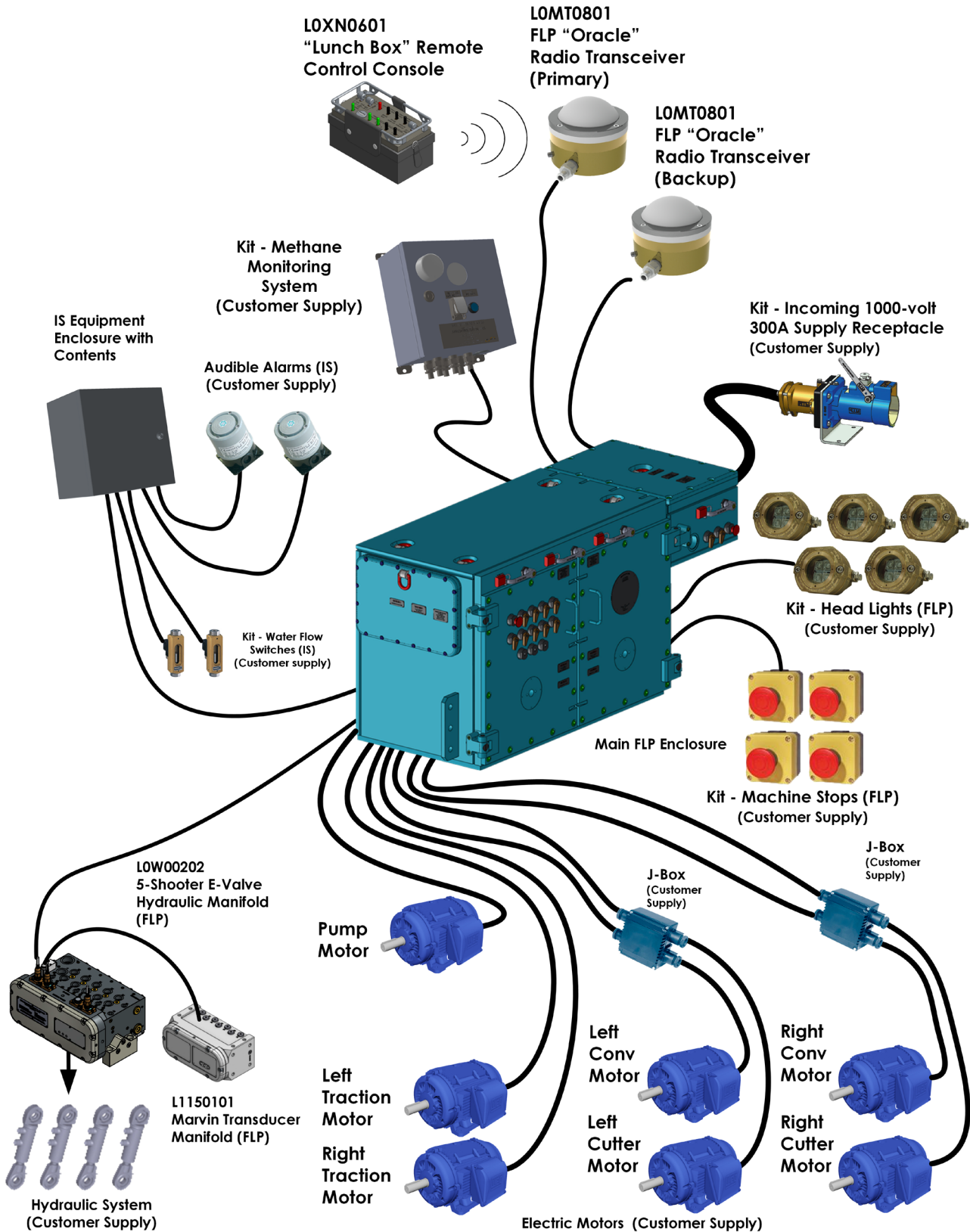

L0QX301 IEC Flameproof Enclosure - Ex d

12CM12 Place Change Miner Control System  
Control System Components

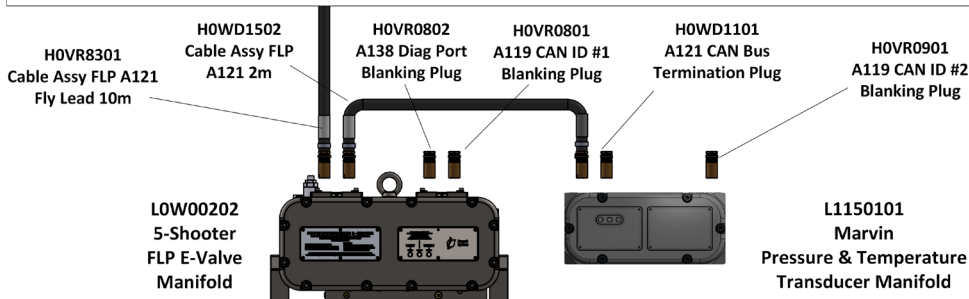
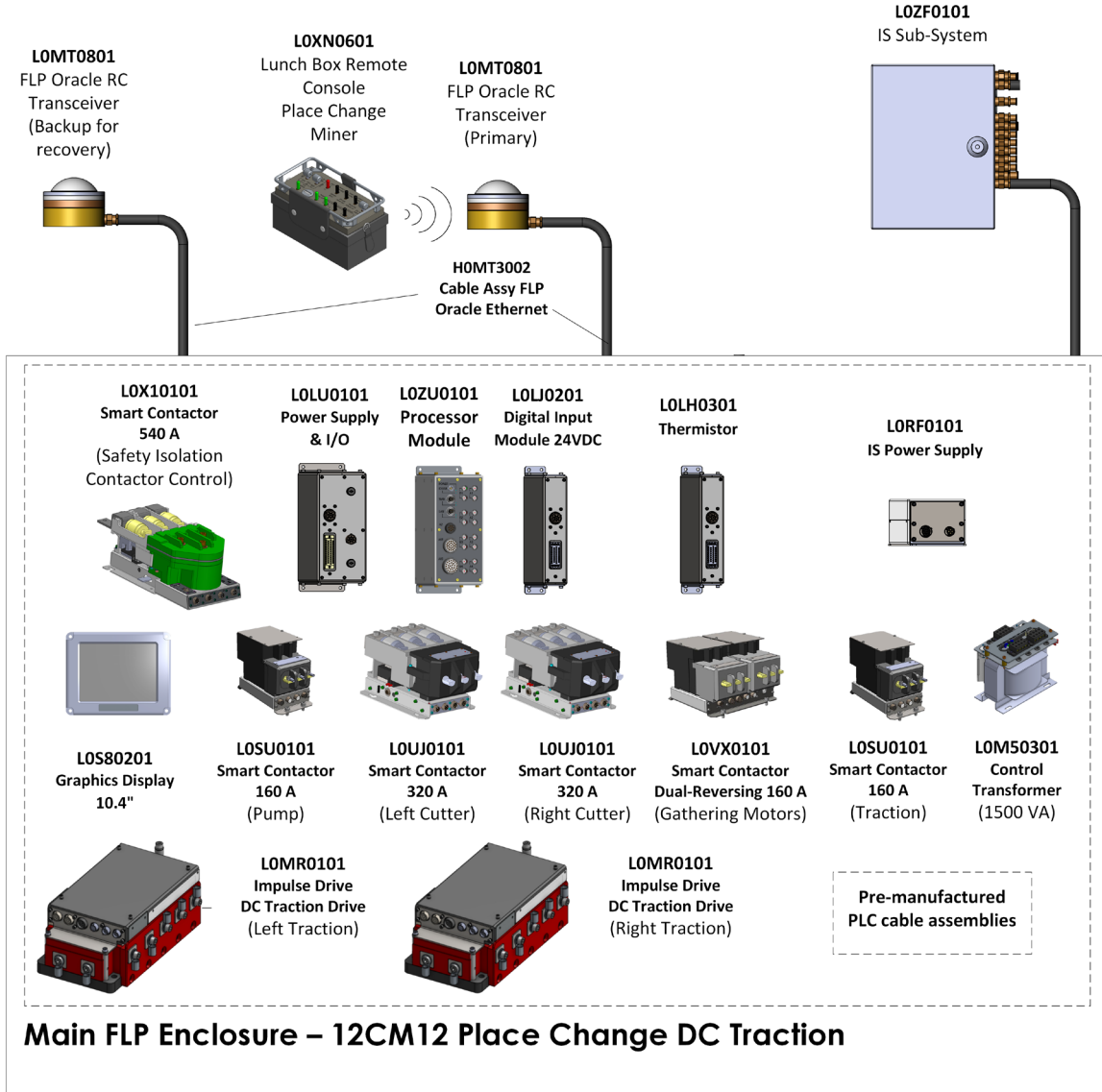

L0QX301 IEC Flameproof Enclosure - Ex d

Control System Modules

Simple, Reliable Networking

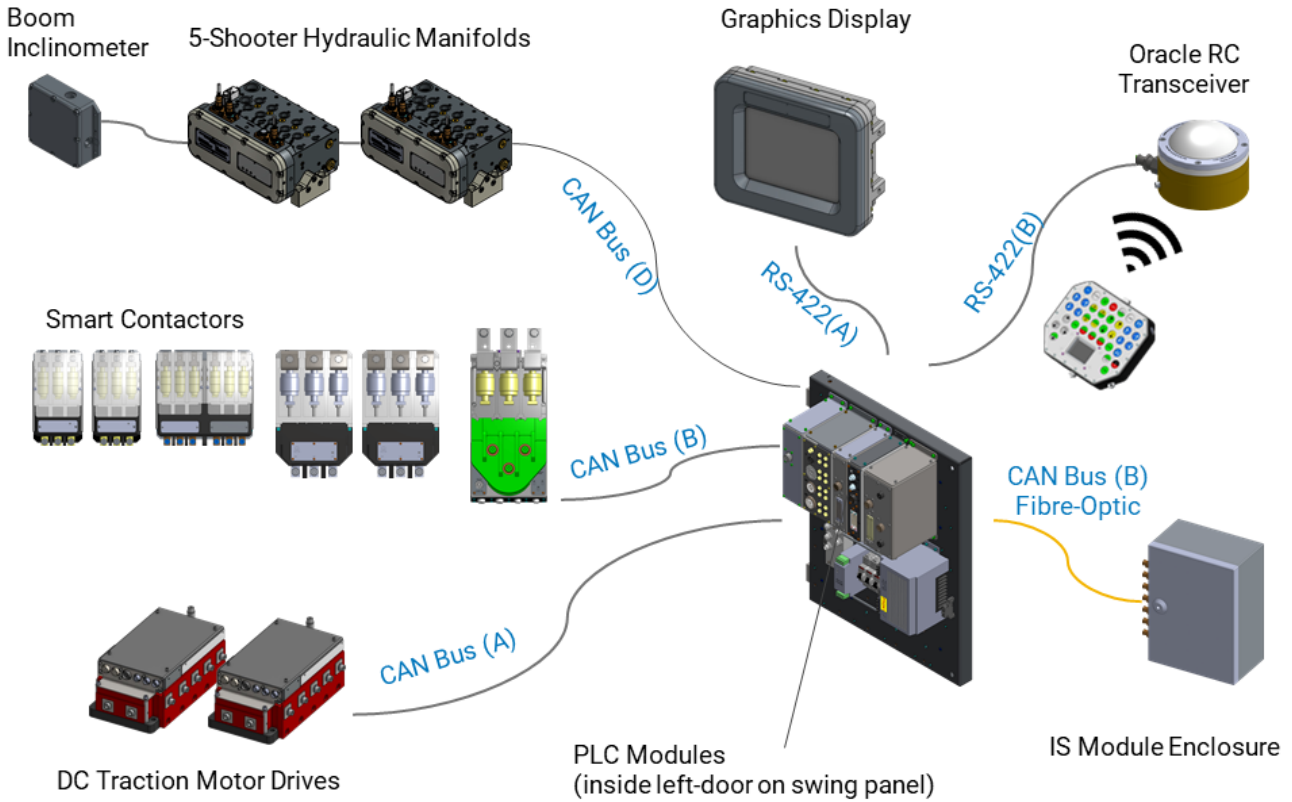

Advanced, User Friendly Diagnostic And Fault Logging

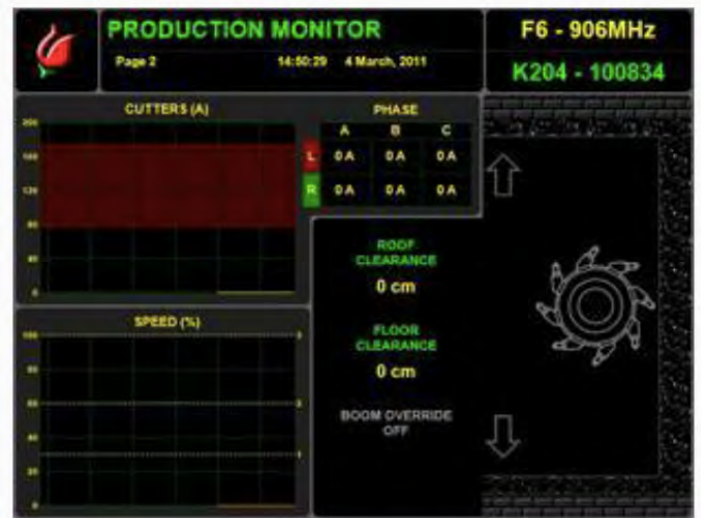
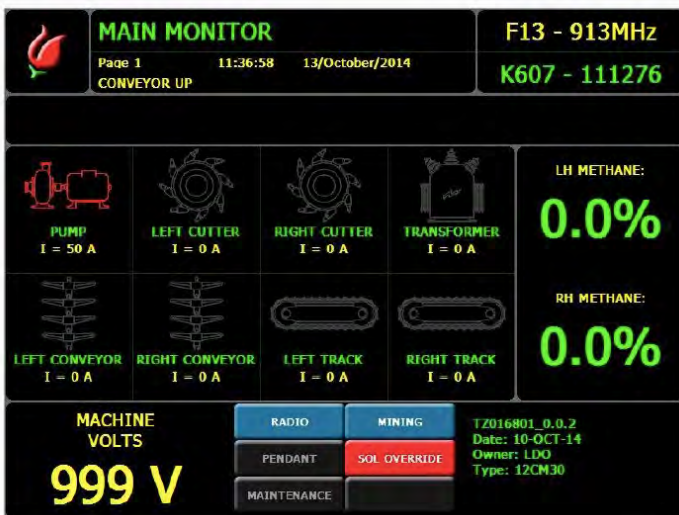

L0QX301 IEC Flameproof Enclosure - Ex d

Simplified Project Management For Your Next Overhaul

Pempek's Supplied Control System Package

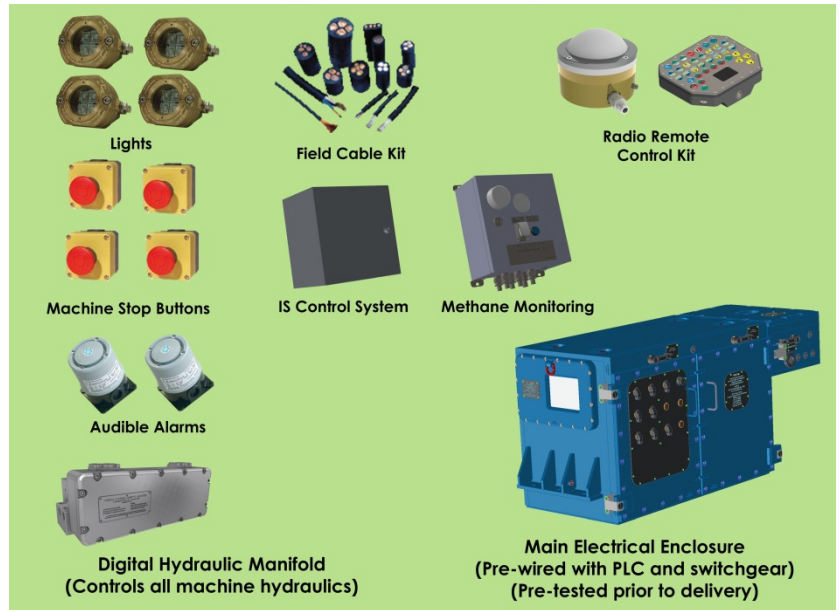

Pempek's Engineering Service

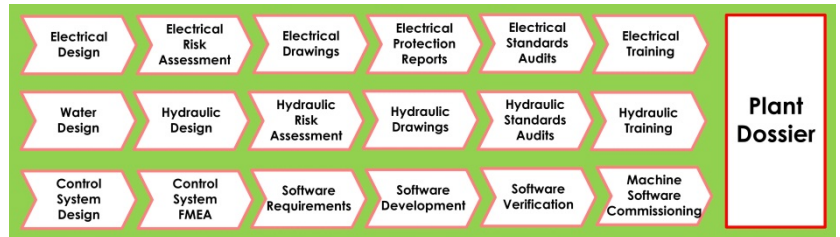

Pempek's Installation Service



Customer Supplied Items



Electric Motors

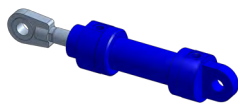

Hydraulic Cylinders



Mining Machine (New manufacture Overhaul or Existing)

## L0QX301 IEC Flameproof Enclosure - Ex d

### Standard Packages Available



Continuous Miners



Bolter Miner



Shuttle Cars



Road Headers



Feeder Breaker